

Isolator Annex 1

Your Presenter: Richard Denk,
Nick Name Mr. Containment

Senior Consultant

Aseptic Processing & Containment @ SKAN AG

- Studied Mechanical Engineering, GMP, Quality Control, Auditing, Hygienic Design, Pharmaceutical Engineering, Qualification/Validation
- PDA: Preventing Contamination and Cross Contamination
- PDA Isolator Expert Group
- PDA Program Committee for the EU ATMP
- PDA Advisory Board for ATMPs
- ISPE Chair CoP Containment and Chair Future Robotics
- ISPE Annex 1 Commenting Group



Draft Annex 1 Contamination Control Strategy for Barrier Systems like Isolators

Your Presenter: Richard Denk, Nick Name Mr. Containment

- ISPE CoP SPP Sterile Product Processing
- ISPE Chair Containment Guide
- PICs/Annex 2 – 2A ISPE Comments Team
- ISO TC 198 Aseptic Processing and Isolators

Annex 1

What were the major driver for the new Annex 1

- Contamination Control Strategy CCS
- Quality Risk Management QRM
- Keep Operators out of critical Aseptic Operations
- Barrier Solutions the preferred technology.

Facilities



Aseptic Fill and Finish



The Rules Governing Medicinal Products in the European Union
Volume 4 EU Guidelines for Good Manufacturing Practice for Medicinal Products for
Human and Veterinary Use

Brussels, 22.8.2022
C(2022) 5938 final

Annex 1

Manufacture of Sterile Medicinal Products

GUIDELINES

The Rules Governing Medicinal Products in the European Union
Volume 4 EU Guidelines for Good Manufacturing Practice for Medicinal Products for
Human and Veterinary Use

2.1 The manufacture of sterile products is subject to special requirements in order to minimize risks of microbial, particulate and endotoxin/pyrogen contamination. The following key areas should be considered:

- i. Facility, equipment and process should be appropriately designed, qualified and/or validated and where applicable, subjected to ongoing verification according to the relevant sections of the Good Manufacturing Practices (GMP) guidelines. The use of appropriate technologies (e.g. Restricted Access Barriers Systems (RABS), isolators, robotic systems, rapid/alternative methods and continuous monitoring systems) should be considered to increase the protection of the product from potential extraneous sources of endotoxin/pyrogen, particulate and microbial contamination such as personnel, materials and the surrounding environment, and assist in the rapid detection of potential contaminants in the environment and the product.



Annex 1

Conventional Aseptic Processing

Highest risk of human intervention

RABS «Restricted Access Barrier System»

Reduced risk of human intervention

Isolators

Lowest risk of human intervention

Facilities



Annex 1

RABS «Restricted Access Barrier System»

- Reduced risk of human intervention

RABS “ Restricted Access Barrier System”

- Operator have access to critical areas
- Barrier but doors can be opened
- Grade B environment.
- Intensive Training and Monitoring
- Different RABS Configurations



Different RABS Technologies

Passive Open RABS

- (Passive) Airflow from HEPA ceiling
- Air overspill into the Room
- Physical barrier with aerodynamic air flow
- Outside Grade B (Iso 7) / Inside Grade A (Iso 5)
- Sporidical gassing only together with clean room
- Doors open able in production
- No toxic products possible

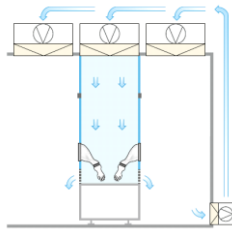

Active Open RABS

- Active Airflow with own HEPA ceiling
- Air overspill into the Room
- Physical barrier with aerodynamic air flow
- Outside Grade B (Iso 7) / Inside Grade A (Iso 5)
- Sporidical gassing only together with clean room
- Doors open able in production
- No toxic products possible

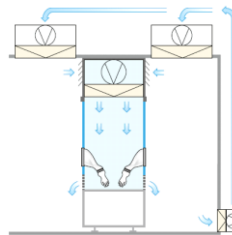

Closed RABS

- Active airflow with air return
- No air overspill into room
- Physical barrier
- Positive or negative pressure, with intake/exhaust air systems
- Outside Grade B (Iso 7) / Inside Grade A (Iso 5)
- Sporidical gassing in closed RABS possible independent of cleanroom
- Doors open not possible during production
- Toxic products possible

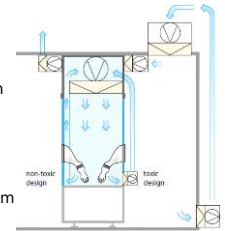

Definitions

Passive open RABS on a syringe line



Definitions

Active open RABS on Freeze Dryer



Closed RABS Example



Annex 1

Isolators

- Lowest risk of human intervention

Isolators

- Operator have no direct access to critical areas
- Validated and accepted decontamination system with H₂O₂
- Reduced Clean Room requirements outside of the Isolator (ISO 7/8 Class C/D)
- Less Gowning of the Operator
- Open and closed Isolator



4.3 Restricted Access Barrier Systems (RABS) or isolators are beneficial in assuring required conditions and minimizing microbial contamination associated with direct human interventions in the critical zone. Their use should be considered in the CCS. Any alternative approaches to the use of RABS or isolators should be **justified**.

Annex 1

Different Isolator Technologies



Closed Isolator



Open Isolator

Contamination Control Strategy for Annex1 Compliance in Isolators



Contamination Control Strategy



**Aseptic
Equipment
Design**

Aseptic Fill and Finish

4.4 For the manufacture of sterile products, there are four grades of cleanroom/zone.

Grade A: The critical zone for high-risk operations (e.g. aseptic processing line, filling zone, stopper bowl, open primary packaging or for making aseptic connections under the protection of first air). Normally, such conditions are provided by a localised airflow protection, such as unidirectional airflow workstations within RABS or isolators. The maintenance of unidirectional airflow should be demonstrated and qualified across the whole of the grade A area. Direct intervention (e.g. without the protection of barrier and glove port technology) into the grade A area by operators should be minimized by premises, equipment, process and procedural design.

4.19 The design of the technology and processes used should ensure appropriate conditions are maintained in the critical zone to protect the exposed product during operations.

i. Isolators:

- a. The design of open isolators should ensure grade A conditions with first air protection in the critical zone and unidirectional airflow that sweeps over and away from exposed products during processing.
- b. The design of closed isolators should ensure grade A conditions with adequate protection for exposed products during processing. Airflow may not be fully unidirectional in closed isolators where simple operations are conducted. However, any turbulent airflow should not increase risk of contamination of the exposed product. Where processing lines are included in closed isolators, grade A conditions should be ensured with first air protection in the critical zone and unidirectional airflow that sweeps over and away from exposed products during processing
- c. Negative pressure isolators should only be used when containment of the product is considered essential (e.g. radiopharmaceutical products) and specialized risk control measures should be applied to ensure the critical zone is not compromised.



First Air – Refers to filtered air that has not been interrupted prior to contacting exposed product and product contact surfaces with the potential to add contamination to the air prior to reaching the critical zone.

Contamination Control Strategy

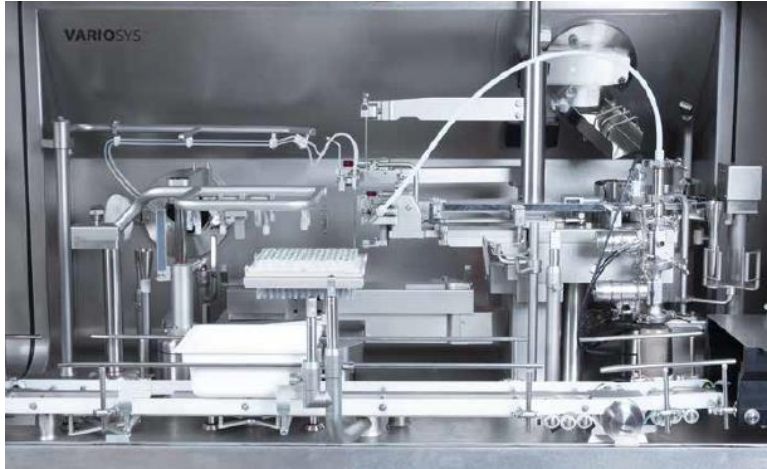

KSF 5105 – Fully automatic vial filling and closing



First Air – Refers to filtered air that has not been interrupted prior to contacting exposed product and product contact surfaces with the potential to add contamination to the air prior to reaching the critical zone.

Comparison with traditional fill and finish technologies

First Air Settle plate handling by robot



PDA Filling Line Workshop on the 4th and 5th of September



ED

<https://www.pda.org/global-event-calendar/event-detail/pda-eu00192-manage-your-aseptic-filling-line>

Contamination Control Strategy

**Sterility
with Isolators and
H₂O₂ Surface
Decontamination**

Contamination Control Strategy

4.30 The speed of air supplied by unidirectional airflow systems should be clearly justified in the qualification protocol including the location for air speed measurement. Air speed should be designed, measured and maintained to ensure that appropriate unidirectional air movement provides protection of the product and open components at the **working position** (e.g. where high risk operations occur and where product and/or components are exposed). Unidirectional airflow systems should provide a homogeneous air speed in a range of 0.36 – 0.54 m/s (guidance value) at the **working position**, unless otherwise scientifically justified in the CCS. Airflow visualization studies should correlate with the air speed measurement.

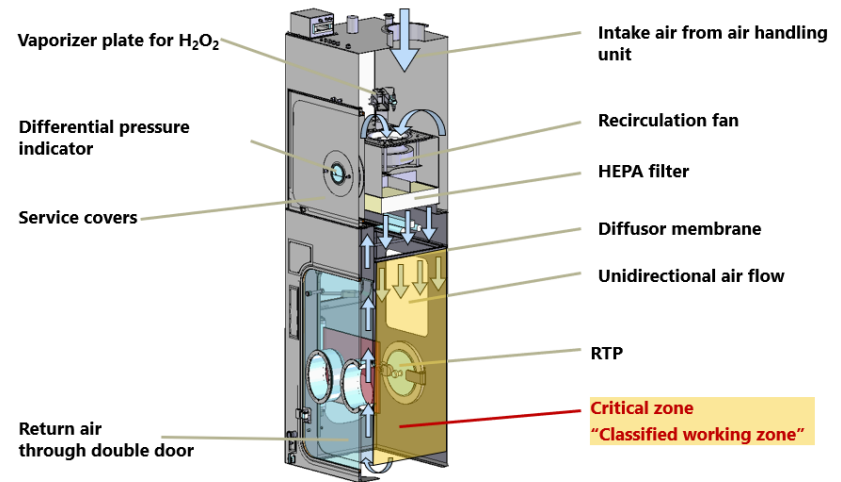
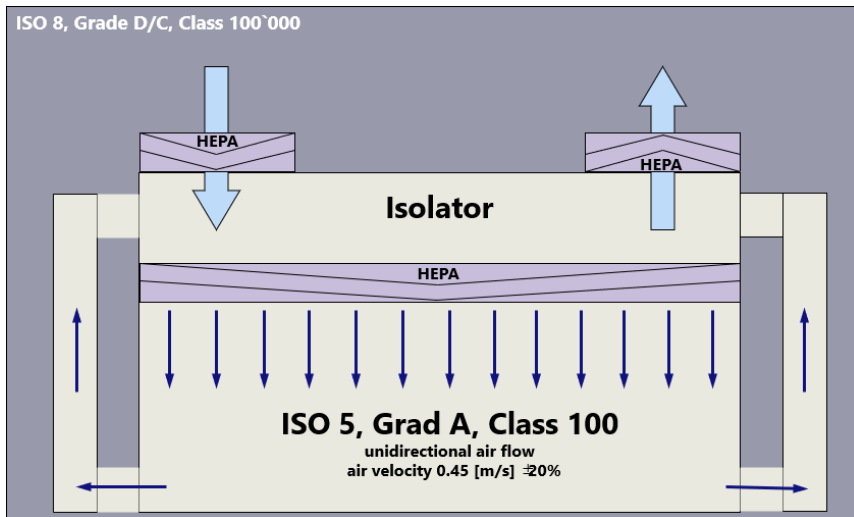

Contamination Control Strategy

i. For isolators

The bio-decontamination process of the interior should be automated, validated and controlled within defined cycle parameters and should include a sporicidal agent in a suitable form (e.g. gaseous or vaporized form). Gloves should be appropriately extended with fingers separated to ensure contact with the agent. Methods used (cleaning and sporicidal bio-decontamination) should render the interior surfaces and critical zone of the isolator free from viable microorganisms.

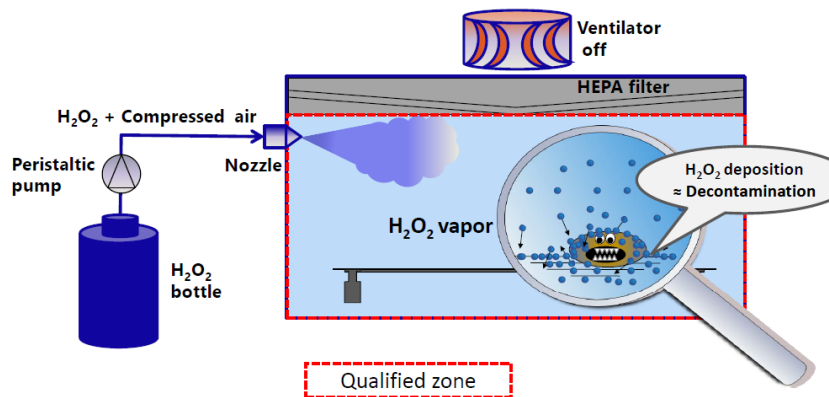

initial conditions

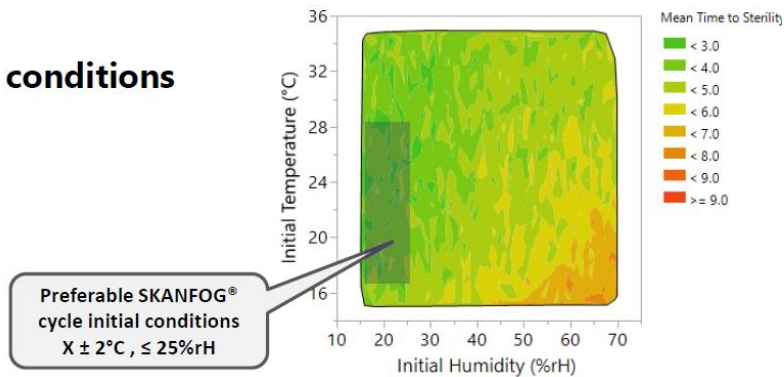

Contamination Control Strategy

→ Dosing unit

→ Vaporizer plate

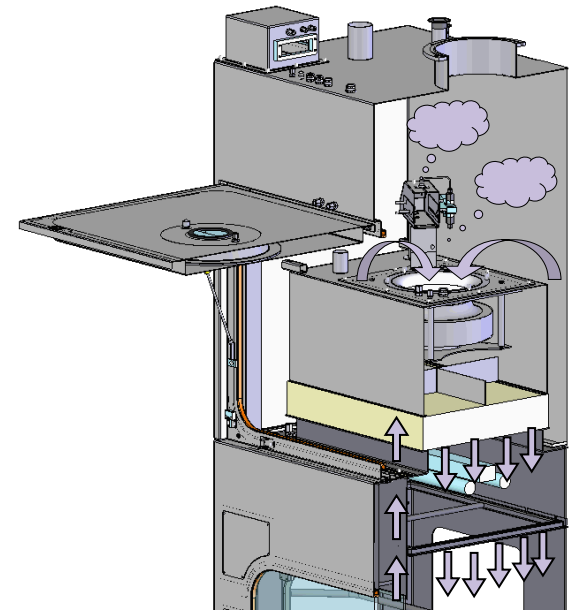
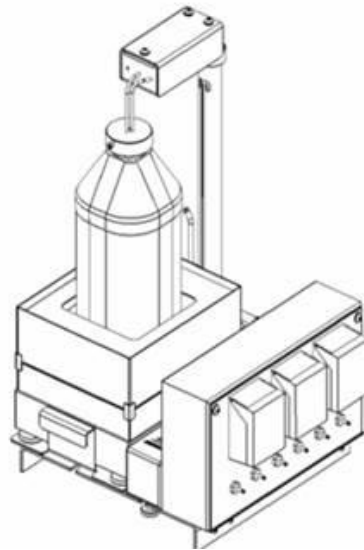

Contamination Control Strategy

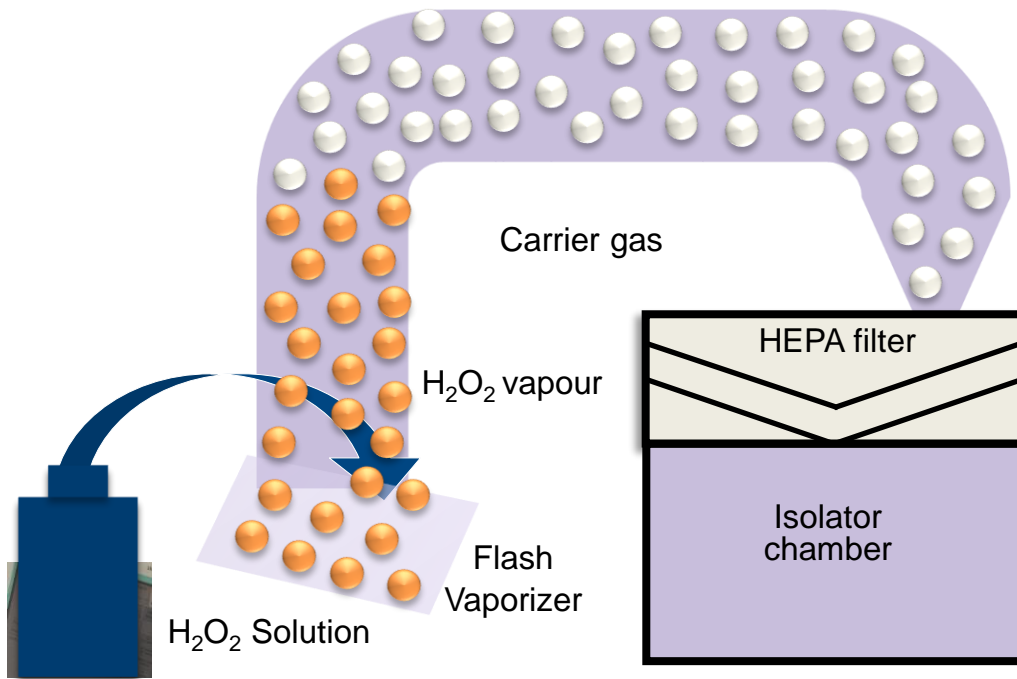

Contamination Control Strategy

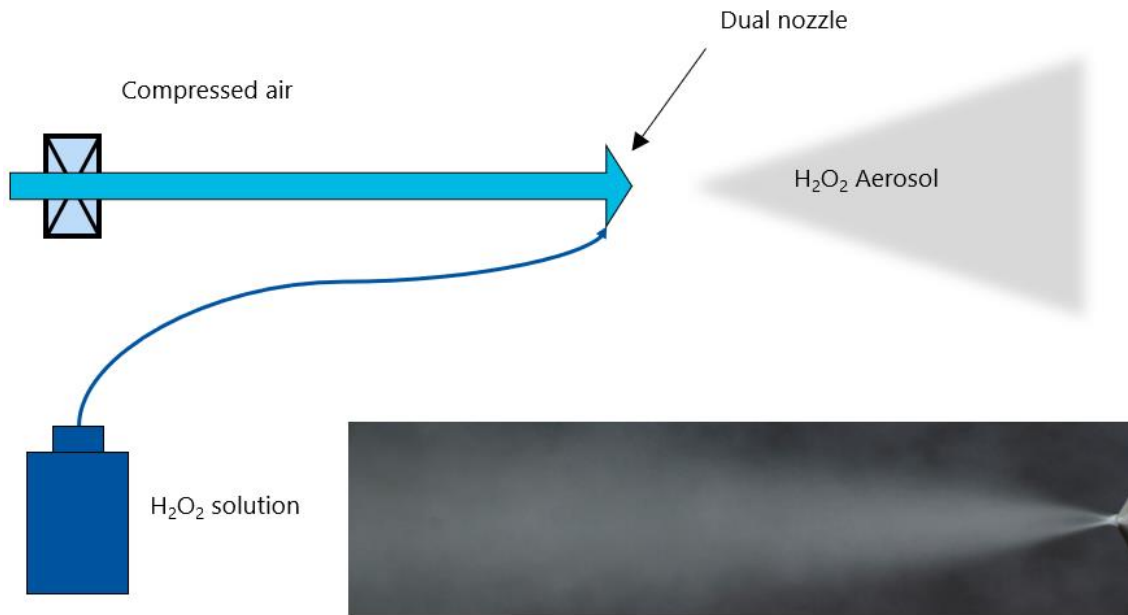

Contamination Control Strategy

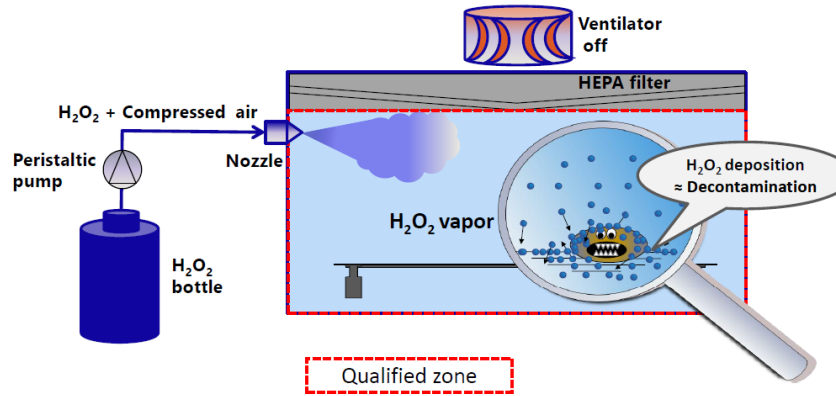

- Surface Decontamination with atomized H_2O_2

initial conditions

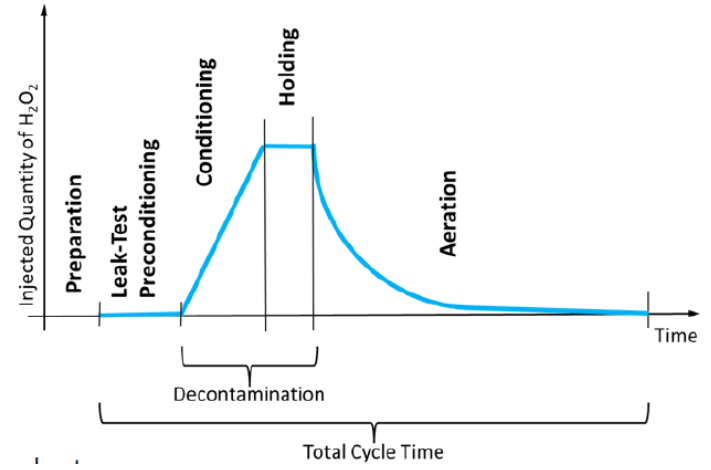
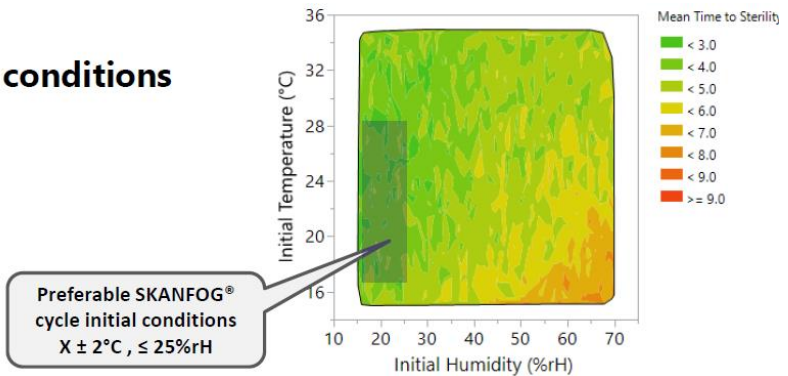

Contamination Control Strategy

Proof of Surface Decontamination with Biological Indicators

8.43 The reliability of BIs is important. Suppliers should be qualified and transportation and storage **condition**s should be controlled in order that BI quality is not compromised. Prior to use of a new batch/lot of BIs, the population, purity and identity of the indicator organism of the batch/lot should be verified. For other critical parameters, e.g. D-value, Z-value, the batch certificate provided by the qualified supplier can normally be used.

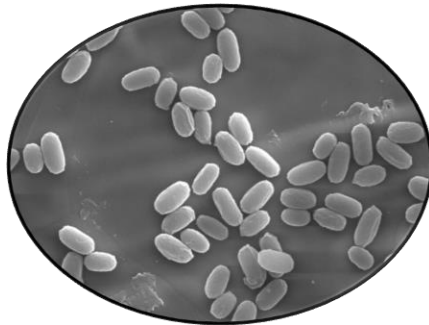

Contamination Control Strategy

Quality Control – GMP Compliance Manufacturing

Decontamination sensor ?

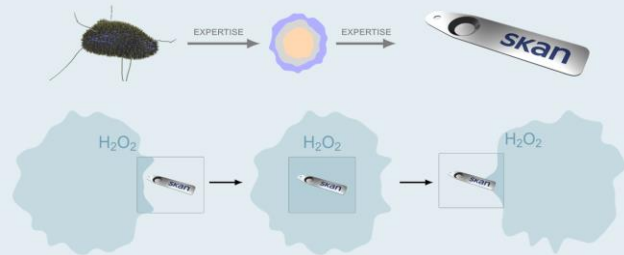

Smart Operations team

- Customer contact (order and information)
- Shipment management (Parcel tracking, customs, GDP, cold chain)
- Lab. equipment management (Monitoring, qualification, calibration)
- Complaint management
- Material ordering process and stock management

Bioprocess team

- In-house media preparation
- General pre-processing of materials
- Core production processes
- Ongoing R&D and technological watch on Bioprocess



In-house Quality Control

Quality Control team

- Environmental monitoring program and hygiene control
- Material entry control program
- Change control and deviation management
- Certification
- Ongoing R&D and technological watch on QC methods



In-house Quality Control

Contamination Control Strategy



**Automation
and
Digitalisation**

The Evolution from Manual Aseptic Operations to fully gloveless Robotics for highly potent APIs

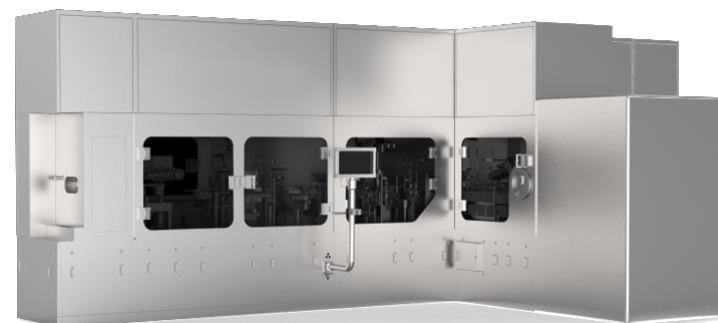

Source: SKAN RoboCell

Fully automated Gloveless Filling line



What is important to consider on 4-x and 6-x Robotics

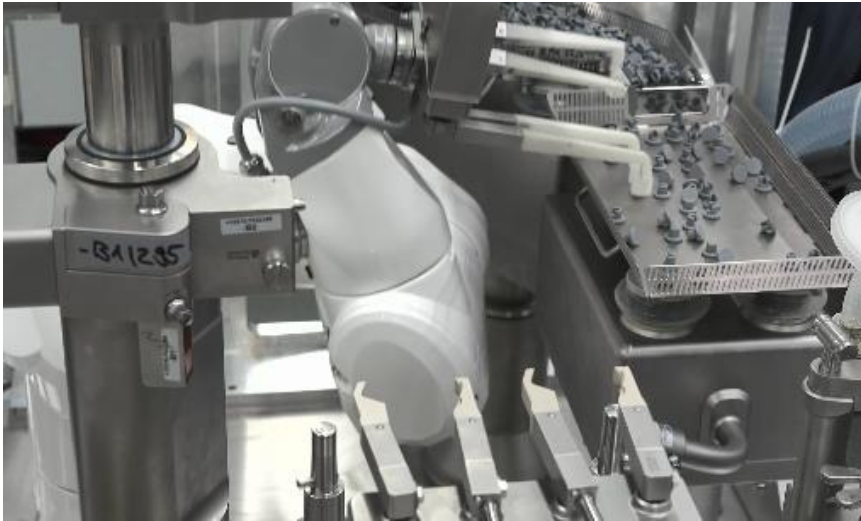

6-x Robot



4-x Robot

Comparison with traditional fill and finish technologies

Installation of the filling path by robot

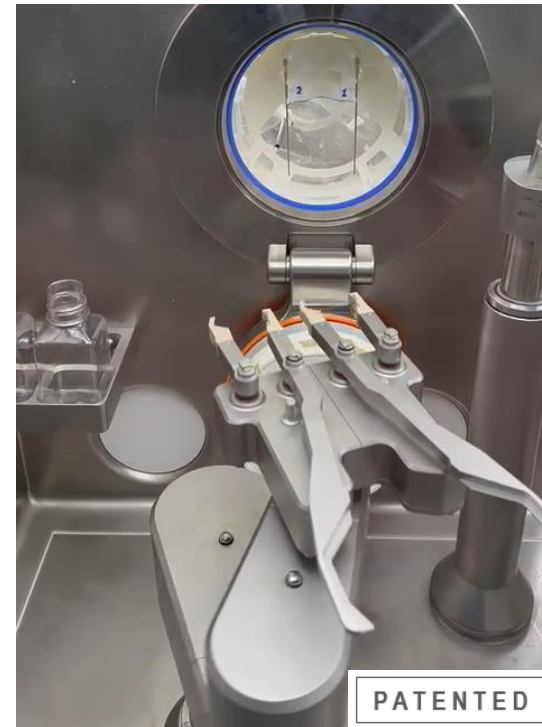

Material Transfers – Ebeam- Connectors

4.10 The **transfer** of equipment and materials into and out of the cleanrooms and critical zones is one of the **greatest** potential sources of contamination. Any activities with the potential to compromise the cleanliness of cleanrooms or the critical zone should be assessed and if they cannot be eliminated, appropriate controls should be implemented.

8.47 Where materials, equipment, components and ancillary items are sterilised in sealed packaging and then transferred into grade A, this should be done using appropriate validated methods (for example, **airlocks** or pass-through hatches) with accompanying disinfection of the exterior of the sealed packaging. The use of rapid transfer port technology should also be considered. These methods should be demonstrated to effectively control the potential risk of contamination of the grade A and grade B areas and, likewise, the disinfection procedure should be demonstrated to be effective in reducing any contamination on the packaging to acceptable levels for entry of the item into the grade B and grade A areas.



Source: Sartorius

Material Transfers

- RTP – Single Use



- E-Beam

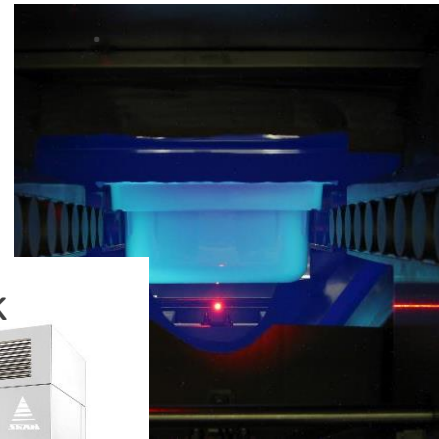

- H2O2 Airlock

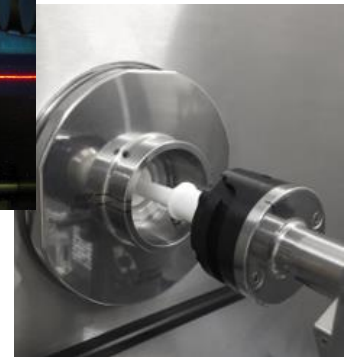

- AT Sterile Connector

- Dry Heat Tunnel

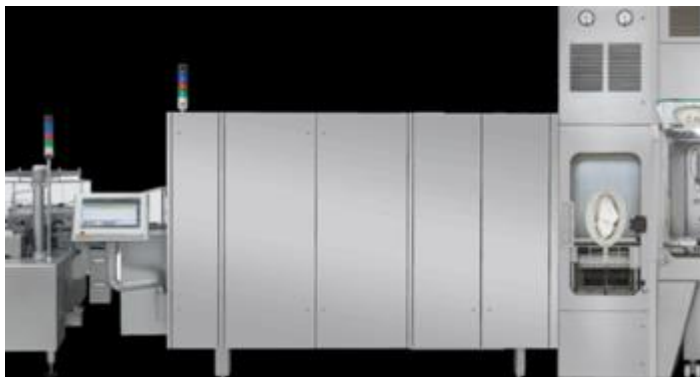

Contamination Control Strategy



CLEAN
to prevent
Contamination/
Cross
Contamination

Contamination Control Strategy

4.21 The materials used for glove systems (for both isolators and RABS), should be demonstrated to have appropriate mechanical and chemical resistance. The frequency of glove replacement should be defined within the CCS.

i. Isolators:

- a. For isolators, leak testing of the glove system should be performed using a methodology demonstrated to be suitable for the task and criticality. The testing should be performed at defined intervals. Generally glove integrity testing should be performed at a minimum frequency of the beginning and end of each batch or campaign. Additional glove integrity testing may be necessary depending on the validated campaign length. Glove integrity monitoring should include a visual inspection associated with each use and following any manipulation that may affect the integrity of the system. For manual aseptic processing activities where single unit or small batch sizes are produced, the frequency of integrity verification may be based on other criteria, such as the beginning and end of each manufacturing session.
- b. Integrity / leak testing of isolator systems should be performed at defined intervals.



Save Time for the Really Important Things in Life
Feeling free with WirelessGT – The established and simple glove leak testing system

Isolator Glove Test

There will be a PDA Paper about Quality Risk Management for Isolator Gloves together with the BPOG.

Contamination Control Strategy

Visual Test

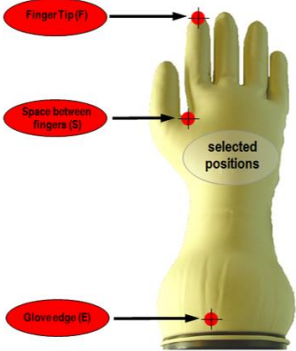
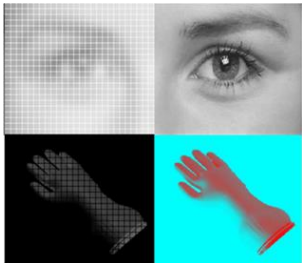

Physical Test

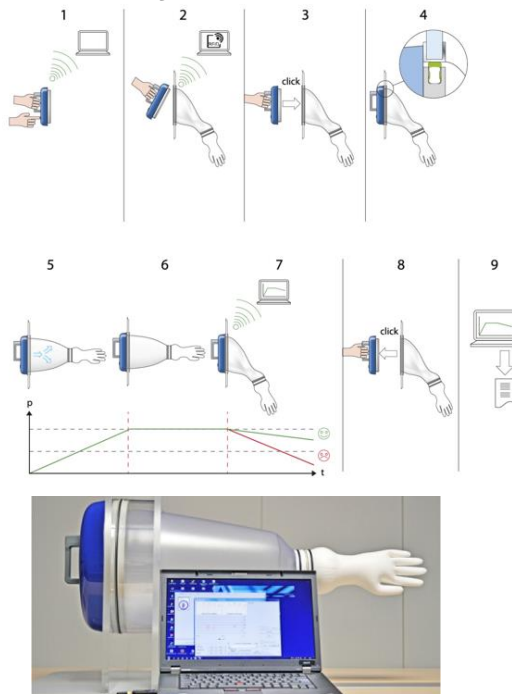

Glove Quality Risk Management

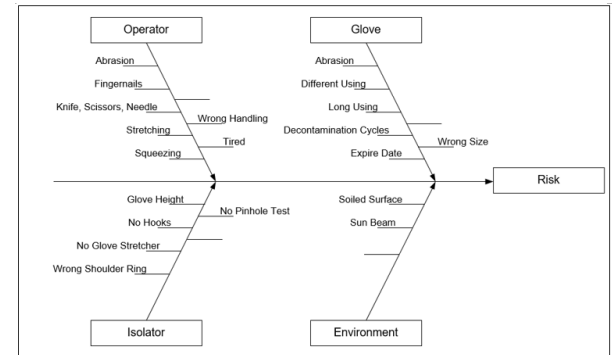

Contamination Control Strategy



**CLEAN™
EH&S**

Contamination Control Strategy

5.4 The **cleaning** process should be validated to be able to:

- i. Remove any residue or debris that would detrimentally impact the effectiveness of the disinfecting agent used.
- ii. Minimize chemical, microbial and particulate contamination of the product during the process and prior to disinfection.



Contamination Control Strategy

Isolators Key to Preventing Cross-Contamination

Richard Denk, SKAN AG, Andreas Flueckinger, MD, Roche, Hirokazu Kisaka, Takeda, Reinhold Maeck, Boehringer Ingelheim, Lars Restetzki, PhD, Roche, Andreas Schreiner, Novartis, Rico Schulze, Landesdirektion Sachsen

When it comes to protection of cleanroom personnel and product, the possibility for contamination both within and on the exterior of an isolator exists. The issue is of particular interest in the manufacturing of pharmaceutical products with highly potent APIs (HPAPIs). Manufacturers must assess isolator design, the routes by which HPAPI can spread (transfer or contact via non-product contact surfaces) and the possibilities for containment with a view to evaluating possible contamination risks within an isolator. Additionally, the cleaning process and cleaning limits for nonproduct contact surfaces within an isolator operated under aseptic conditions, as well as cleaning and air concentration limits outside the isolator, should also be considered.

Validation of the cleanliness of non-product contact surfaces has increased in popularity since EMA proposed the following measures to demonstrate effective management of the cross-contamination risk in Chapter 5.21 of Part 1 of its GMP guidelines: "Depending on the contamination risk, verification of cleaning of non-product contact surfaces and monitoring of air within the manufacturing area...in order to demonstrate effectiveness of control measures against airborne contamination or contamination by mechanical transfer."

In aseptic manufacturing, isolators are used to reduce direct access by personnel to the critical stages of manufacture (fill-finish), and to contain the cleanroom area in which critical stages take place. As an example, the fill-finish area within an isolator is designed as Zone A/ISO Class 5, and the area outside is Zone D/ISO Class 8 for the European Union and ISO Class 7 for the United States. Protection of personnel handling HPAPIs is another reason for using isolators.

But how does a classic aseptic isolator differ from an isolator used for the aseptic manufacture of HPAPIs? With a classic



isolator, the isolator is supplied with conditioned air for Zone A via unidirectional air flow. The return air from the isolator to the recirculation fan travels through the double wall of the isolator (1). Spread of released HPAPIs from the isolator to the isolator plenum is possible, thus the classic isolator is not suitable for the use of HPAPIs (Figure 1).

ditioned air for Zone A via unidirectional air flow. The return air from the isolator to the recirculation fan travels through the double wall of the isolator (1). Spread of released HPAPIs from the isolator to the isolator plenum is possible, thus the classic isolator is not suitable for the use of

For an HPAPI isolator, an additional filter level is included before the air return into the isolator plenum. This filter level is located directly before the air return ducts, preventing HPAPI from spreading into the return air ducts and the isolator plenum. See Figure 2 for a single-wall isolator with

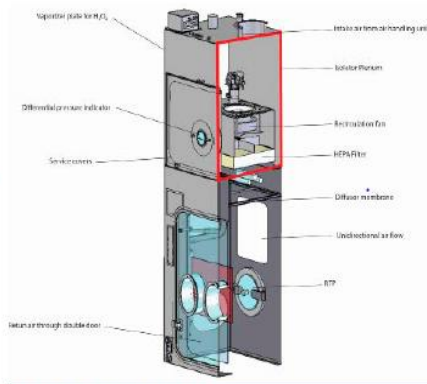

Figure 1 Isolator with double-walled air return chamber

Validation of the cleanliness of non-product-contact surfaces has increased in popularity since the EMA proposed the following measures in order to demonstrate effective management of the cross-contamination risk (in Chapter 5.21 of Part 1 of its GMP guidelines): "Depending on the contamination risk, verification of cleaning of non-product contact surfaces and monitoring of air within the manufacturing area [...] in order to demonstrate effectiveness of control measures against airborne contamination or contamination by mechanical transfer."

- of different medicinal products in shared facilities (20 November 2014) EMA/CHMP/CVMP/SWP/169430/2012
- 4. "Riboflavin test for low-germ or sterile process technologies." Information sheet. Mechanical Engineering Industry Association. (December 2007).

About the Authors

Richard Denk is Head of Sales Containment for SKAN. He has spent nearly 20 years in the production of highly active/ highly hazardous substances and has developed the containment pyramid.

Andreas Flueckiger, MD, is in charge of the Roche Group's occupational health and hazard assessment programs.

Hirokazu Kisaka joined Takeda Pharmaceutical Company in 1988 and currently works for Takeda as Head of Regional Engineering Japan and Asia.

Reinhold Maeck works at Boehringer Ingelheim as Head of Regulatory Intelligence EHS&S. He has more than 20

years of experience in the pharmaceutical industry.

Lars Restetzki, PhD is Business Process Manager in Roche's Rocephin manufacturing plant.

Andreas Schreiner, PhD, is Head of Validation for Solid Dosage Forms in Novartis' Manufacturing Science and Technology Organization.

Rico Schulze is a GMPD Inspector with the local GXP inspectorate in Dresden, Germany. He is also the head of the German authorities' expert group on radiopharmaceuticals.



Contamination Control Strategy

PDA Journal
of Pharmaceutical Science and Technology



Preventing Cross-Contamination during Lyophilization: GMP and Occupational Cleaning Requirements for Nonproduct and Indirect Product-Contact Parts

Richard Denk, Andreas Flückiger, Hirokazu Kisaka, et al.

PDA J Pharm Sci and Tech 2019, 73 487-495
Access the most recent version at doi:10.5731/pdapst.2018.009530

RESEARCH

Preventing Cross-Contamination during Lyophilization: GMP and Occupational Cleaning Requirements for Nonproduct and Indirect Product-Contact Parts

RICHARD DENK^{1,4}, ANDREAS FLÜCKIGER², HIROKAZU KISAKA³, STEPHAN KRAUSE⁴, REINHOLD MAECK⁵, LARS RESTETZKI⁶, ANDREAS SCHREINER⁷, and RICO SCHULZE⁸

¹SKAN AG, Binningerstrasse 116, 4123 Allschwil, Switzerland; ²F. Hoffmann-La Roche Ltd., Switzerland; ³Takeda, Japan; ⁴AstraZeneca; ⁵Boehringer Ingelheim GmbH, Germany; ⁶F. Hoffmann-La Roche Ltd., Switzerland; ⁷Novartis, Switzerland; and ⁸GMP Inspectorate at Landesdirektion Sachsen, Germany © PDA, Inc. 2019

ABSTRACT: A detailed overview is provided for the possible patient exposure to highly potent active pharmaceutical ingredients (HPAPIs) from potential cross-contamination through the lyophilization process. The intent of this paper is to raise awareness of the risk(s) to patients and stimulate the implementation of adequate risk-based controls, such as containment process(es), use of adequate surrogates in cleaning validation/verification, and test method-sensitivity-based cleaning validation acceptance conditions. Although lyophilizers are considered to be nonproduct-contact surfaces because their surfaces and fixtures do not usually come into direct contact with the product, product contamination can occur at critical locations within a lyophilizer and/or during the unloading process. Contamination of the air because of released product particles can also create a risk. Therefore, special attention should be paid to HPAPIs, as the permitted daily exposures (PDEs) for patients are particularly low. During a lyophilizer cycle, areas of concern are spreading of the lyophilizer HPAPI powder because of air turbulence, contaminated plates, mechanical transfer systems, and spreading because of damaged vials or contaminated stainless steel or plastic surfaces. Specific considerations for contamination containment for the lyophilizer unloading process are presented. Suggestions are provided for the prevention of patient exposure through cross-contamination via direct-contact areas and prevention of manufacturing personnel exposure via non-direct-contact areas. A surface limit(s) of 1 PDE per square decimeter for nonproduct-contact surfaces inside a lyophilizer is proposed. Risk-based cleaning validation/verification strategies are discussed, with specific consideration of the quality control test method sensitivity expectations and use of suitable surrogates for lyophilized products in the cleaning verification studies.

It is a requirement from the occupational health perspective that exposure to chemicals (API) be primarily controlled by engineering measures and not by the use of personal protective equipment.

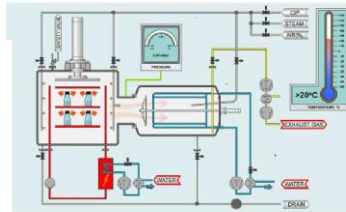

Proposed EH&S and GMP surface limits for non-product contact surfaces inside an Lyophilisator with the assumption of above closed loading and unloading of the Lyophilisator with Isolator technology.

Simplified assumption OEL= PDE / 10 To be verified by expert team and based on box data		Limit for surface with no direct product contact inside the Lyophilisator (µg/dm ²) Worker safety and GMP	Limit for "public" surface with uncontrolled possibility of unprotected hand contact (µg/dm ²) Driven by worker safety
PDE (µg/d)	OEL (µg/m ³)		
10000	1000	Visual clean	Visual clean
1000	100	Visual clean	100
100	10	100	10
10	1	10	1
1	0.1	1	0.1
0,1	0,01	0,1 or lower	0,01 or lower

Contamination Control Strategy

Simplified assumption OEL= PDE / 10 To be verified by expert team and based on tox data		Limit for surface with no direct product contact inside the Isolator ($\mu\text{g}/\text{dm}^2$) GMP and Operator safety	Limit for "public" surface with uncontrolled possibility of unprotected hand contact ($\mu\text{g}/\text{dm}^2$) Driven by Operator safety	Limit for airborne API inside of isolator after cleaning at product changeover ($\mu\text{g}/\text{dm}^3$) Driven by GMP
PDE ($\mu\text{g}/\text{d}$)	OEL ($\mu\text{g}/\text{m}^3$)			
10000	1000	Visually clean	Visually clean	10000
1000	100	Visually clean	100	1000
100	10	100	10	100
10	1	10	1	10
1	0.1	1	0.1	1
0,1	0,01	0,1 or lower	0,01 or lower	0,1 or lower

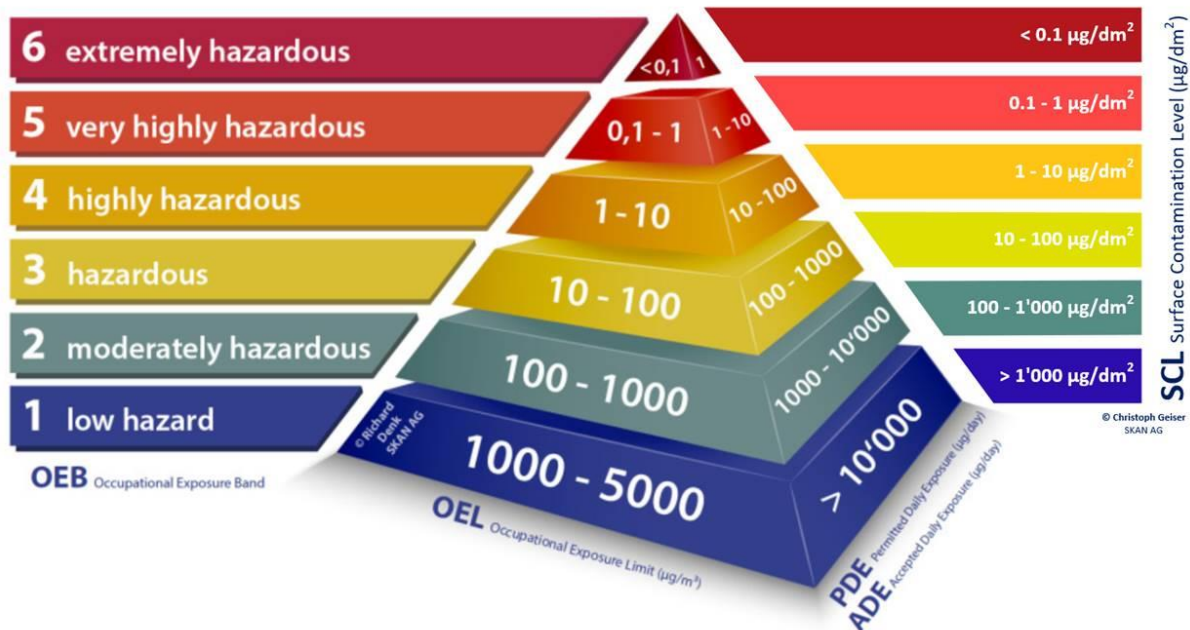

Interview with Matt Davis from the TGA and Francesco Cicirello Former TGA and PIC/s

What are the major findings during Inspection?

- «Unappropriate Cleaning especially in Multi Purpose Facilities».



Every life matters and we are driven by the mission to provide access to important medicines.

Richard Denk, Senior Consultant, Aseptic Processing & Containment, Skan AG
Matt Davis, Senior GMP Inspector, TGA
Francesco Cicirello, Director, Quality Assurance, Evelo Biosciences

ISPE



PDA Points to Consider Published June 2020



Points to Consider for the Aseptic Processing of Sterile Pharmaceutical Products in Isolators

- <https://www.pda.org/bookstore/product-detail/5699-points-to-consider-isolators>



Thank you!
Questions?

Richard Denk

richard.denk@skan.ch